

Symmetrical Horn TP Antenna Gen2

HORN ANTENNA WITH TWISTPORT™ CONNECTOR

Symmetrical Horn Antennas have a symmetrical beam pattern with no sidelobes. They offer excellent noise rejection and supreme scalability options. They are perfect for high-density AP clusters and dense radio co-location.

Symmetrical Horn TP Antennas Gen2 feature our industry-changing TwistPort™ connector, a patent-pending quick-locking waveguide port. TwistPort™ is virtually lossless and revolutionary easy to use.

Symmetrical Horn TP Antennas Gen2 feature multiple improvements on RF performance and industrial design, incl. optically lighter antenna body and significantly improved antenna bracket. Radome is made of more resistant material and the whole range of Gen2 antennas only uses two different radome sizes.



TECHNICAL DATA

Antenna Connection	TwistPort™ - Quick Locking Waveguide Port
Antenna Type	Horn
Materials	UV Resistant ABS Plastic, Polycarbonate, Polypropylene, Aluminium, Stainless Steel
Environmental	IP55
Flame Rating	UL 94 HB
Pole Mounting Diameter	30-80 mm (we recommend as close to 80mm as possible)
Temperature	-30°C to +55°C (-22°F to +131°F)
Wind Survival	160 km/hour
Wind Loading	22 N at 160 km/hour
Mechanical Tilt	± 25°
Weight	1.4 Kg / 3.0 lbs – single unit 2.2 Kg / 4.8 lbs – single unit incl. package 23.0 Kg / 50.7 lbs – carton (10 units)
Single Unit	Retail Box: 305 × 239 × 183 mm / 12 x 9.4 x 7.2 inch
10 Units	Carton Box: 940 × 510 × 335 mm / 37 x 20 x 13.2 inch

PRODUCT DIMENSIONS

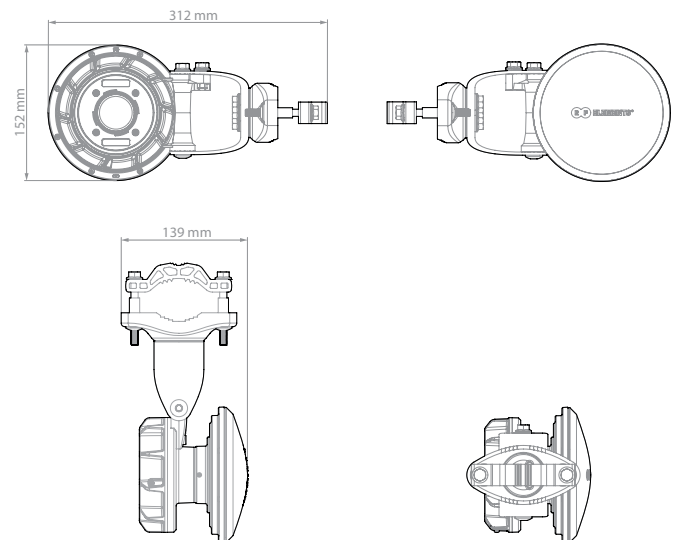

PERFORMANCE

Frequency Range	5180 - 6400 MHz
Gain	9.6 dBi
Azimuth Beam Width -3 dB	H 67° / V 67°
Elevation Beam Width -3 dB	H 67° / V 67°
Azimuth Beam Width -6 dB	H 90° / V 90°
Elevation Beam Width -6 dB	H 90° / V 90°
Beam Efficiency**	92%
Front-to-Back Ratio	28 dB

AZIMUTH PATTERN

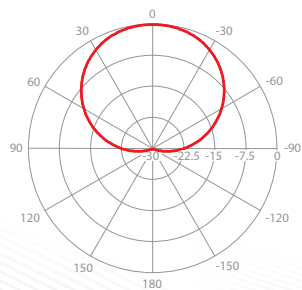

V/H - Port Pattern Azimuth 5.6 GHz

ELEVATION PATTERN

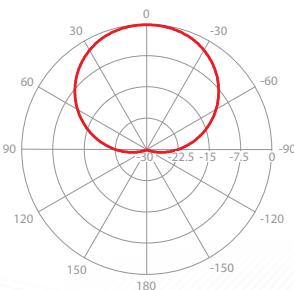

V/H - Port Pattern Elevation 5.6 GHz

**Beam efficiency defined up to first null

GAIN

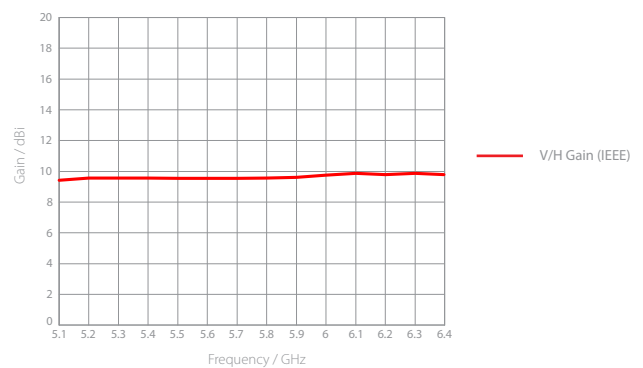

3D RADIATION DIAGRAM

SCALE: 30dBi

COMPATIBLE WITH: ADOBE ACROBAT READER DC. NOT SUPPORTED ON MOBILE.

USE MOUSE TO ROTATE THE DIAGRAM. SCROLL IN/OUT TO ZOOM IN/OUT

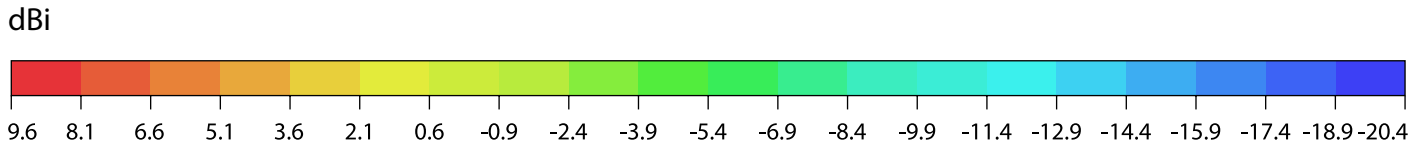

FRONT	BACK	RIGHT	LEFT	UP	DOWN
-------	------	-------	------	----	------